

BOURDON
The Original by Baumer



Main Features

- Excellent repeatability
- Dead band adjustment for regulation
- Fix dead band for control and alarm
- Intrinsic safety Hazardous area 0, 1, 2

Applications

- Power generation safety equipment

Technical Data

Temperature range	-46 ... 0 °C to 200 ... 270 °C	Electrical connection	Terminal block with plastic cable gland for Ø 7 to 10.5 mm
Temperature	Process: -46 ... +270 °C Ambient: -30 ... + 55 °C Storage: -40 ... + 55 °C	Electrical function	See ordering code details on page 5
Repeatability	± 1% F.S. / constant temperature cycle	Adjustment	2 external adjustment screws on top of the case for set point and dead band
CE conformity	Low Voltage Directive 2014/35/EU ATEX Directive 2014/34/EU	ATEX/IECEX	<u>Certificate</u> LCIE 03 ATEX 6123X IECEX LCIE 15.0060X
Protection rating	IP 66 (EN 60529)	<u>Classification</u>	C € Ex I M 1 Ex ia I Ma Ex II 1 G Ex ia IIC T6 or T5 Ga
Process connection	Stainless steel 1.4404 (316L)	<u>Electrical data</u>	$U_{max} = 28 \text{ Vdc}$ $I_{max} = 120 \text{ mA}$ $P_{max} = 0.84 \text{ W}$ $C_i = \text{Negligible}$; $L_i = \text{Negligible}$
Bulb	Stainless steel 1.4435/1.4404 (316L)		
Capillary	RTA: Copper alloy RTN: Stainless steel 1.4404 (316L) For types of protection see ordering details on page 5		
Scale	Internal. Accuracy on reading ± 5% F.S.		
Cover	Zamak blue painted Captive stainless steel screws		
Case	Black Zamak		
Mounting	Direct mounting or with wall mounting bracket		
Ground connection	Via internal terminal block		

Options

Customer specific set point adjustment	Code SETP
Mounting on 2" pipe	Code 0407
Stainless steel tag plate and wire	Code 9941
Lead seal of the adjustment screws	Code 8990
Nuclear cleanliness (RTN only)	Code 0838
Electrical connection: stainless steel connector (Souriau)	Code 2298
Mobile plug for stainless steel connector (Souriau)	Code 2249

Principle

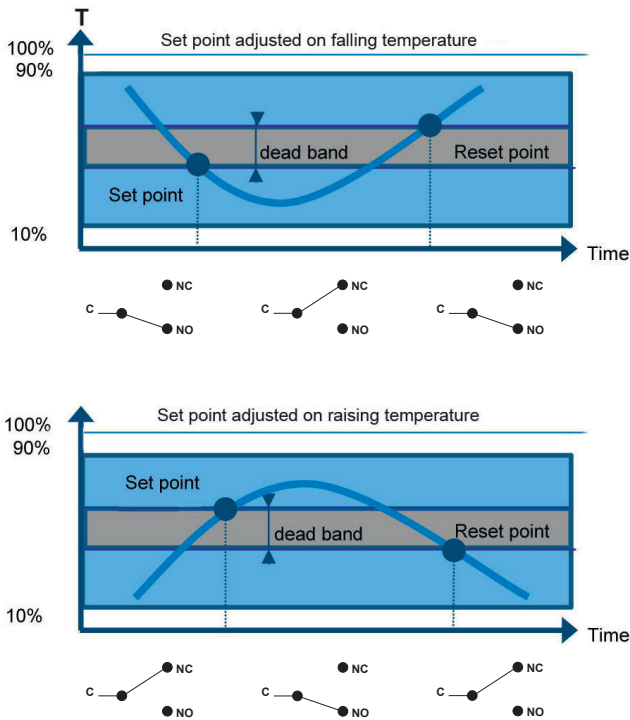

A vapour filled flexible sensing element actuates a microswitch by means of a lever. The set point is adjusted by means of a compressible spring installed in opposition.

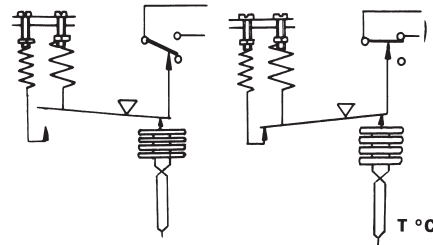

Set point and reset point must be between 10% and 90% of the selected scale.

Standard factory adjustment

Setpoint at 50% of the scale on falling temperature

Customer specific factory adjustment (option SETP)

The following specifications have to be given with the order:

- Setpoint value
- Adjustment on falling or raising temperature
- Dead band value (as needed) when using an adjustable dead band switch

Electrical connections

1 SPDT

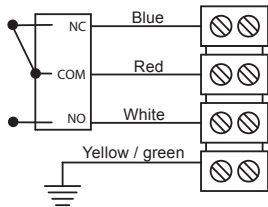

2 SPDT

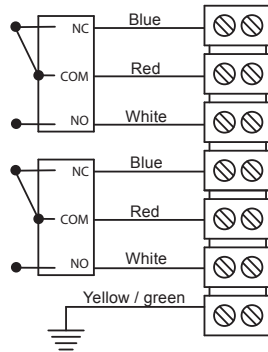

Hazardous area
Zone 0, 1, 2

Certified safety
barrier

Non hazardous
area

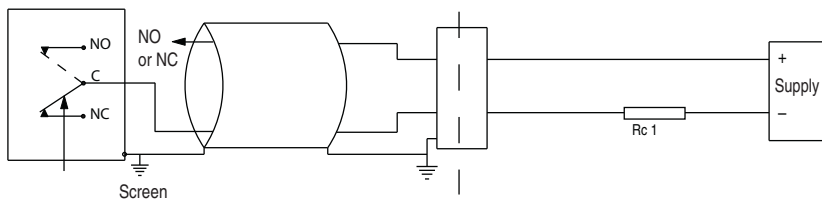

For max. ambient temperature refer to technical data on page 1.

The installation must be made in an intrinsically safe circuit whose certified electrical safety parameters do not exceed any of the values U_{max} , I_{max} and P_{max} given in the electrical data on page 1.

All necessary measures must be taken by the user, to avoid the calorific transfer from the fluid to the apparatus head increasing the head's temperature to such that it reaches the self-ignition temperature of the gas in which it is used.

Micro switches characteristics

Switch code	M (K)	C (W)	S
Type	Gold contact	Hermetic	Ultrasensitive Gold contact
6 Vdc	10 ... 50 mA	5 ... 120 mA	10 ... 50 mA
12 Vdc	10 ... 50 mA	5 ... 120 mA	10 ... 50 mA
24 Vdc	10 ... 50 mA	5 ... 120 mA	10 ... 50 mA
30 Vdc	N/A	N/A	N/A
48 Vdc	N/A	N/A	N/A
110 Vdc	N/A	N/A	N/A
220 Vdc	N/A	N/A	N/A
115 Vac	N/A	N/A	N/A
250 Vac	N/A	N/A	N/A
Dielectric rigidity between contacts and ground	2000 V	1500 V	2000 V

Adjustable ranges

Scale	T _{Max} accidental	Code	Micro-switch dead band ⁽¹⁾					
			Adjustable dead band				Fixed dead band	
			M (K*)		C (W*)		S	
			10%	90%	10%	90%	10%	90%
°C			°C					
-46 ... 0	40	400	4 - 9	2 - 9	8 - 12	4 - 12	3	2,5
-20 ... 20	60	401	3 - 8	1,5 - 6	6 - 10	4 - 10	2,5	1,5
0 ... 45	60	402	4 - 9	2 - 9	7 - 12	4 - 12	3	2
40 ... 120	145	403	5 - 16	3 - 16	10 - 20	6 - 20	4	3,5
100 ... 160	180	414	5 - 12	3 - 12	9 - 15	5 - 15	4	3
20 ... 80	100	415	5 - 12	3 - 12	9 - 15	5 - 15	4	3
160 ... 250	290	406	6 - 18	4 - 18	11 - 22	7 - 22	5	3,5
70 ... 150	175	408	5 - 16	4 - 16	10 - 20	6 - 20	4	3
130 ... 190	210	412	5 - 12	3 - 12	9 - 15	5 - 15	4	3
200 ... 270	290	413	5 - 12	3 - 12	9 - 15	9 - 15	4	3

(*) For version with 2 microswitches lower values of the dead band must be multiplied x 1.5

⁽¹⁾ The value of the dead band is depending on the value of the set point.

This table contains the dead band values for set point adjustment at 10% and 90% of the selected scale. For adjustable dead band the lower value corresponds to the dead band spring totally released and the higher corresponds to the dead band spring fully tensed. For other set points the dead band value can be calculated by linear interpolation between the values at 10% and 90%.

Dimensions (mm)

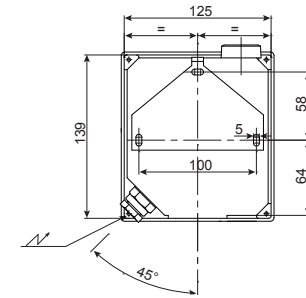
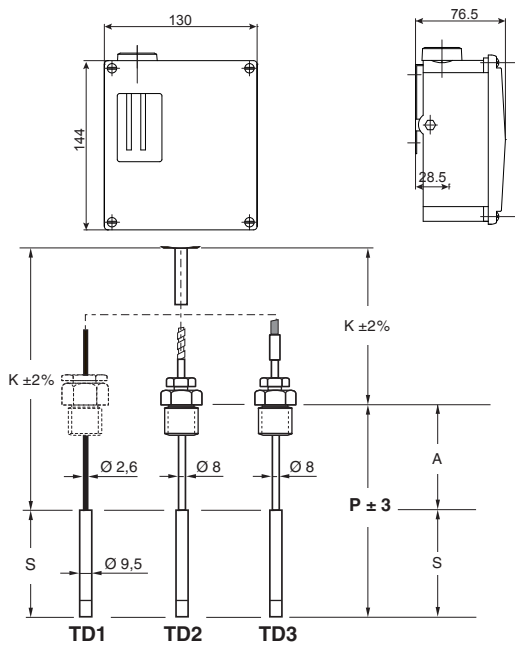

- S** = Bulb length (temperature sensitive part, see tables below)
- A** = Additional stem length
For versions TD2/3, $A_{\min} = 25$ mm
For version TD1 there is no additional stem length ($A=0$).
The sliding connection is mounted on the capillary.
- P** = Immersion length ($P = S + A$)
- P_{min}** = Minimum immersion length ($P_{\min} = S + A_{\min}$)
- K** = Capillary length

Bulb length (S) according to the capillary length (K) and the temperature range (code)

Bulb Ø 14 mm	Code	400	401	402	403	406	408	412	413	414	415
K = 0 ... 2 m	S / mm	80	80	80	80	80	80	80	80	80	80
K = 3 ... 7 m	S / mm	100	100	100	100	100	100	100	100	100	100
K = 8 ... 16 m	S / mm	150	150	150	150	150	150	150	150	150	150
K = 17 ... 20 m	S / mm	180	180	180	180	180	180	180	–	180	180

Bulb Ø 9.5 mm	Code	400	401	402	403	406	408	412	413	414	415
K = 0 ... 2 m	S / mm	155	155	155	155	155	155	155	155	155	155
K = 3 ... 7 m	S / mm	200	200	200	200	200	200	200	200	200	200
K = 8 ... 16 m	S / mm	300	300	300	300	300	300	300	300	300	300
K = 17 ... 20 m	S / mm	370	370	370	370	370	370	370	–	370	370

Stainless steel sliding male connection (TD1)

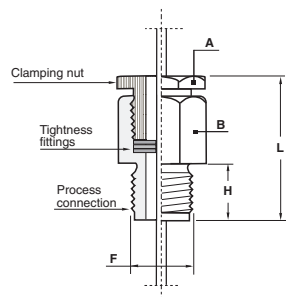

Thread and sizes		
F	G 1/2	1/2 NPT
H	18	21
L	43	46
A	27/flat	27/flat
B	27/flat	27/flat

Waterproof after tightening mounted on the capillary.

Stainless steel sliding male connection (TD2/3)

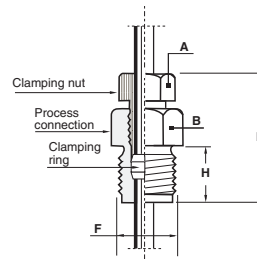

Thread and sizes		
F	G 1/2	1/2 NPT
H	18	21
L	36	40
A	17/flat	17/flat
B	23/flat	23/flat

After tightening of the clamping nut, the stem is fixed in the process connection. Tight up to 40 bar.

Ordering details RTNY4 - RTAY4

		RT	-	Y	.	4xx	.					/
Model		RT										
Industrial temperature switch												
Type of the bulb												
Stainless steel bulb and Copper alloy capillary				A								
Stainless steel bulb and capillary				N								
Approval												
ATEX/IECEX intrinsic safety				Y								
Type of micro switches												
Deadband												
1 SPDT hermetically changeover switch				Adjustable								C
2 SPDT hermetically changeover switch				Adjustable								W
1 SPDT gold contact changeover switch				Adjustable								M
1 SPDT tropicalized changeover switch				Adjustable								K
1 SPDT ultrasensitive gold contact changeover switch				Fix								S
Temperature range (°C)												
-46 ... 0												400
-20 ... 20												401
0 ... 45												402
40 ... 120												403
100 ... 160												414
20 ... 80												415
160 ... 250												406
70 ... 150												408
130 ... 190												412
200 ... 270												413
Type of capillary												
TD1				Capillary without protection								1
TD2				Capillary with stainless steel protection								2
TD3				Capillary with stainless steel protection and PVC coating								3
Capillary length (K)												
1 meter												1
2 meters												2
3 meters												3
4 meters												4
5 meters												5
6 meters												6
7 meters												7
8 meters												8
9 meters												9
10 meters												A
11 meters												B
12 meters												C
13 meters												D
14 meters												E
15 meters												F
16 meters												G
17 meters												H
18 meters												J
19 meters												K
20 meters												L
Immersion length (P)												
Immersion length (P) = Bulb length (S) + additional stem length (A)												
P = S + 25 mm (For S, see tables on page 4)												0
P = 150 mm (not for TD1)												3
P = 160 mm (not for TD1)												2
P = 250 mm (not for TD1)												4
P = 400 mm (not for TD1)												5
P = 600 mm (not for TD1)												6
P = 1000 mm (not for TD1)												D
Bulb diameter												
Ø 14 mm (standard)												E
Ø 9.5 mm												C
Process connection												
Without												0
G1/2												3
1/2 NPT												6

Options to be added behind the / (see example below)

Ordering example with options

RT	-	A	Y	C	.	400	.	2	1	2	E	3	/	0407	-	9941
----	---	---	---	---	---	-----	---	---	---	---	---	---	---	------	---	------

